

SALVATORI

DAL 1946



BATHROOM COLLECTION



For over 70 years at Salvatori we have pushed the boundaries of stone, constantly experimenting with different ways to use it. From our earlier textures such as Dune and perennial favourite Bamboo, through to relative newcomers Raw and Romboo, we have sought to take the hardworking and enduring properties of stone and refine them in surprising and elegant ways.

More recently we have applied this approach to the bathroom environment, developing products and collections that are both hard-wearing and beautiful. Year on year we have added to our repertoire, designing new products in house or working with designers who share our love of natural stone.

We have always held two clear objectives in mind, however. Firstly, we have striven to eliminate as much as possible of the stress and work which often arise when it comes to installing stone features. Coordinating plumbers, builders and stone masons can be costly, time-consuming and energy-sapping, so our solution is a series of bathtubs, basins and showers which can be installed with a minimum of fuss.

This practical aspect aside, we have also focused on aesthetics and the idea of achieving a "total look" encompassing walls, floors, tubs, basins, shower trays and even accessories. The result is a bathroom which goes beyond being merely functional and instead becomes a beautiful space in its own right.

Gabriele Salvatori
Tuscany
Italy

Salvatori è da oltre sessant'anni un'azienda leader nel settore della lavorazione della pietra, costantemente impegnata nella sperimentazione di soluzioni innovative per l'impiego di questo straordinario materiale. Dalle prime texture, come Dune e l'intramontabile e richiestissimo Bamboo, alle proposte più recenti come Raw e Romboo, il marchio Salvatori ha saputo sfruttare sapientemente la sua conoscenza sviluppando processi di lavorazione sempre più sofisticati per la realizzazione di soluzioni inedite, esclusive ed eleganti.

Abbiamo sviluppato la nostra linea bagno con lo stesso approccio, dando vita a prodotti e collezioni sia funzionali che di design. Anno dopo anno abbiamo fatto crescere il nostro catalogo prodotti grazie anche alla collaborazione con importanti designer di fama internazionale che condividono la nostra stessa passione per la pietra.

Il nostro obiettivo principale è quello di limitare lo stress ed il lavoro che spesso l'installazione dei prodotti in pietra comporta. Coordinare idraulici, muratori e marmisti può rivelarsi molto oneroso in termini di tempo, denaro ed energie, di conseguenza abbiamo pensato a soluzioni inedite, proponendo linee di vasche da bagno, lavabi e docce che si contraddistinguono per la facilità di installazione.

Oltre a questo aspetto pratico, abbiamo concentrato la nostra attenzione sul design nell'intento di ottenere un "total look" armonioso che comprendesse pareti, pavimenti, vasche da bagno, lavabi, piatti doccia e anche gli accessori, trasformando così l'ambiente bagno in uno spazio non solo funzionale, ma in un'esperienza da vivere in tutta la sua bellezza.

Gabriele Salvatori
Toscana
Italia

Adda Collection 2-15

Fontane Bianche Collection 16-35

Onsen Collection 36-43

Ishiburo Collection 44-51

Basins / Lavabi 52-69

Shower trays / Piatti Doccia 70-87

Bathtubs / Vasche 88-95

Fontane Bianche Accessories /

Accessori Fontane Bianche 96-103

PLAT-EAU 104-111

Installation & Care /

Installazione e Manutenzione 112-115





With a nod to the wooden décor of the 1950s and 60s, designer David Lopez Quincoces has created a retro-contemporary collection that plays with the inherent properties of each material in the coolness of marble and the warmth of wood.

Comprising a series of round and rectangular basins and modular drawers in two different lengths, Adda creates a sensation of warmth and comfort. Its rich-toned walnut wood has been transformed into a classic ribbed finish by some of Italy's finest wood workers and the stone basins are crafted and hand-finished in Tuscany.

Adda is a collection which sits comfortably in both bathroom and living environments thanks to its modular storage / console system with wooding facing and stone top. It can be used in conjunction with a basin or on its own to display a television, books or other objects, with the additional advantage of the discreet storage solution offered by its drawers.

Con un accenno agli arredi degli anni 50 e 60, il designer David Lopez Quincoces ha creato una collezione retrò ma al tempo stesso contemporanea grazie al sapiente abbinamento del legno con la pietra naturale.

Adda infonde una sensazione di comfort e calore. Il legno, nelle tonalità del noce, è lavorato con una caratteristica finitura a coste da alcuni fra i migliori falegnami italiani mentre le superfici in pietra sono realizzate e rifinite a mano nel nostro stabilimento in Toscana. La serie è composta sia da soluzioni freestanding che sospensione, tonde o rettangolari, e da cassetti modulari componibili in due differenti lunghezze e altezze.

La collezione Adda si adatta perfettamente sia agli ambienti bagno che living grazie al suo sistema di cassetti modulari e componibili che danno la possibilità di essere utilizzati sia come ripiani di appoggio ed elemento contenitivo che come pratica soluzione per i mobili lavabo.

Adda Collection









WALL
PARETE
Pietra d'Avola Lithoverde®

FLOOR
PAVIMENTO
Honed Pietra d'Avola
Pietra d'Avola Levigato

BASIN
LAVABO
Adda wall-mounted
in Pietra d'Avola
Adda lavabo integrato
in Pietra d'Avola

Adda Collection Fact Sheet Caratteristiche Tecniche

MATERIALS
MATERIALI

Bianco Carrara
Crema d'Orcia
Grigio Versilia
Gris du Marais
Pietra d'Avola
Silk Georgette

Natural stone
combined with walnut
wood
Pietra naturale
abbinata a noce
canaletto

Wall-mounted countertop basin
Mobile modulare sospeso con lavabo da appoggio

DIMENSIONS
DIMENSIONI

89.4 × 46.1 × 20 cm
35¼ × 18½ × 7⅞"

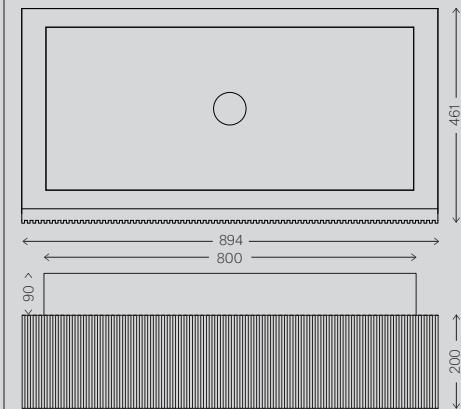

59.4 × 46.1 × 20 cm
23⅜ × 18½ × 7⅞"

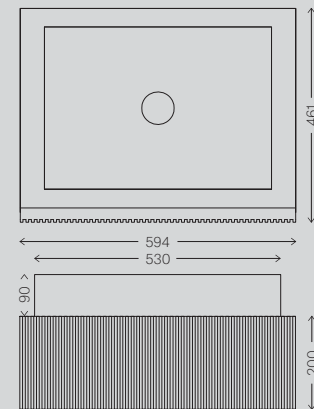

89.4 × 46.1 × 40 cm
35¼ × 18½ × 15¾"

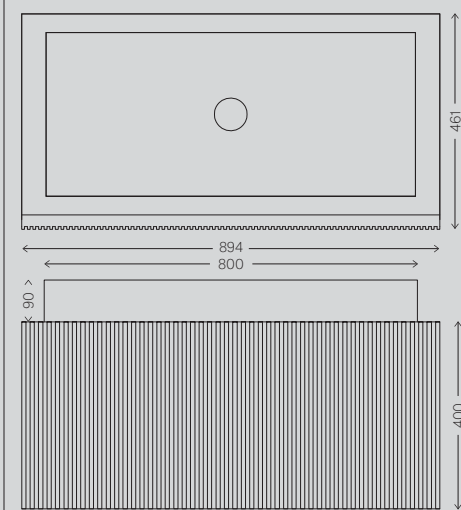

59.4 × 46.1 × 40 cm
23⅜ × 18½ × 15¾"

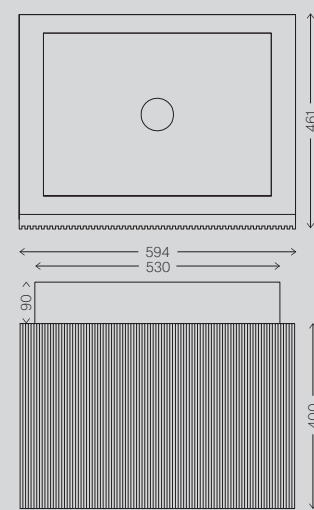

Should you so wish, the Adda basin may be substituted with any countertop basin from the Salvatori range.

Il piano del mobile è allestibile, in alternativa alla soluzione consigliata, con tutti i lavabi da appoggio in pietra naturale delle collezioni Salvatori.

Wall-mounted integrated basin
Mobile modulare sospeso con lavabo integrato

DIMENSIONS
DIMENSIONI

89.4 × 46.1 × 20 cm
35¼ × 18½ × 7⅞"

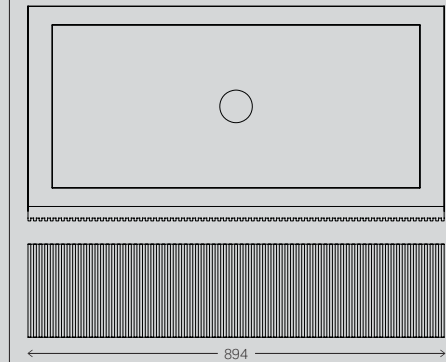

59.4 × 46.1 × 20 cm
23⅜ × 18½ × 7⅞"

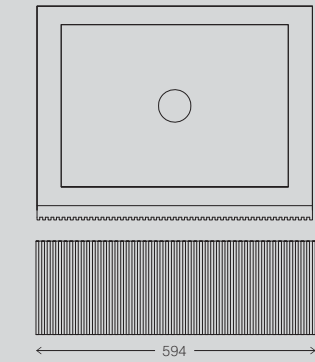

89.4 × 46.1 × 40 cm
35¼ × 18½ × 15¾"

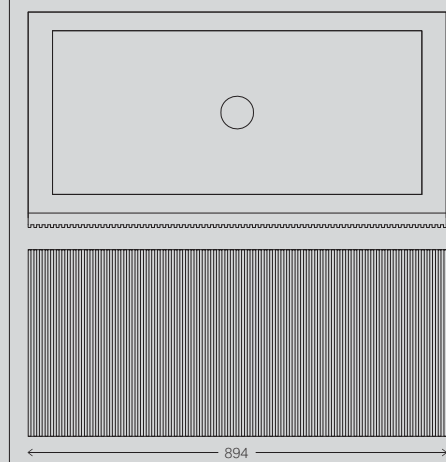

59.4 × 46.1 × 40 cm
23⅜ × 18½ × 15¾"

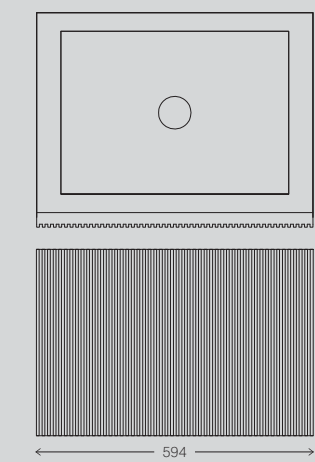

41.4 × 40.8 × 40.6 cm
16¼ × 16½ × 16"

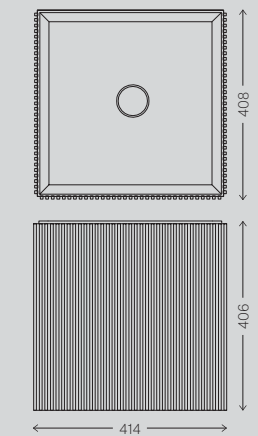

Freestanding basins
Lavabi freestanding

DIMENSIONS
DIMENSIONI

41.7 × 90.6 cm
16⅝ × 35⅝"

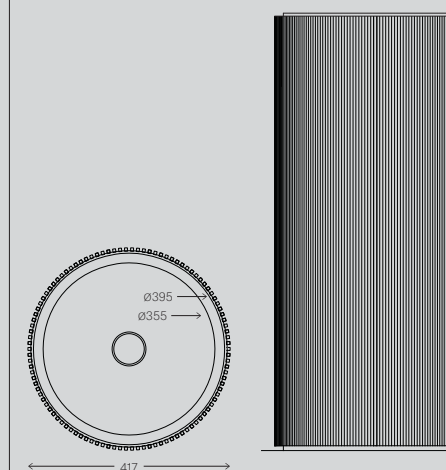

41.4 × 41.4 × 90.6 cm
16¼ × 16¼ × 35⅝"

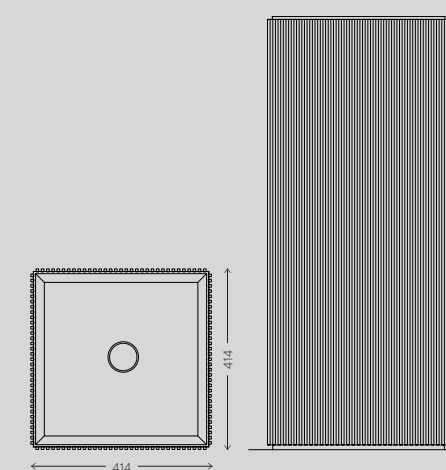

Modular drawers
Cassetti componibili

DIMENSIONS
DIMENSIONI

89.4 × 46.1 × 20 cm
35¼ × 18½ × 7⅞"

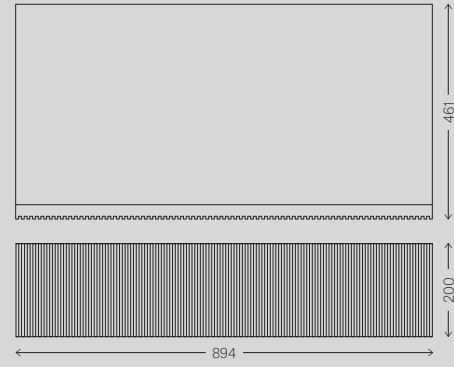

59.4 × 46.1 × 20 cm
23⅜ × 18½ × 7⅞"

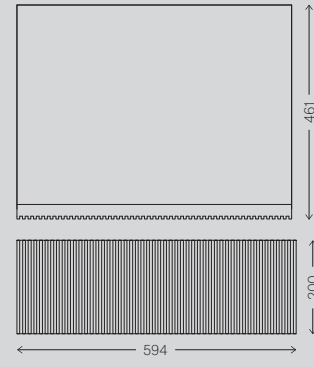

89.4 × 46.1 × 40 cm
35¼ × 18½ × 15⅞"

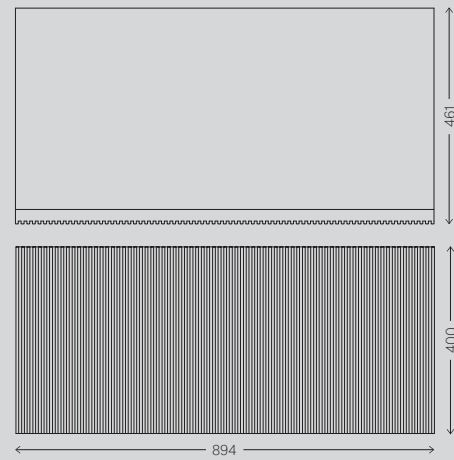

59.4 × 46.1 × 40 cm
23⅜ × 18½ × 15⅞"

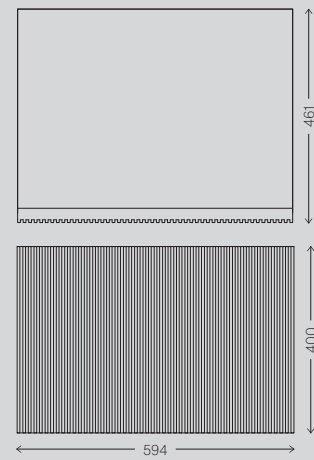

* Technical drawings in mm

WALL
PARETE
Pietra d'Avola Lithoverde®

BASIN, TOP AND
MODULAR DRAWERS
LAVABO, PIANO E
CASSETTI COMPONIBILI
Adda in Pietra d'Avola

MIRROR
SPECCHIO
Archimede Circle

LAMP
LAMPADA
Urano 18

CEILING LIGHT
LAMPADA A
SOSPENSIONE
Silo Trio in Pietra d'Avola

ACCESSORIES
ACCESSORI
Fontane Bianche in
Pietra d'Avola





This collection by Elisa Ossino takes both its name and inspiration from the Sicilian beach known as Fontane Bianche ('White Fountains' in English) which lies close to where Elisa herself grew up.

Playing with the purity of geometric forms, the deceptively simple pieces exemplify the concept of "artisan craft meets precision engineering". The uber-fine borders and delicate finishing of the basins in natural stone are offset by elegantly masculine taps, mixers and shower heads.

Fontane Bianche is based on the Plug & Play philosophy, in that it is extremely simple to install, and comes supplied complete with a kit including waste and brackets.

Fontane Bianche, disegnata da Elisa Ossino per Salvatori, comprende lavandini, mobili contenitori modulari, specchi e rubinetterie. Si ispira alla spiaggia siciliana "Fontane Bianche" situata vicino a dove è cresciuta la designer stessa.

Giocando con la purezza delle forme geometriche, questi prodotti, ingannevolmente semplici, esemplificano il concetto dell' "artigianalità che incontra l'ingegneria di precisione". I bordi sottilissimi e la delicatezza dei lavabi in pietra naturale sono equilibrati dall'eleganza di rubinetti, miscelatori e soffioni.

Fontane Bianche si basa sulla filosofia Plug & Play: è estremamente semplice da installare e viene fornita completa di piletta e supporti a muro.

Fontane Bianche Collection

Previous page
Pagina precedente

WALL
PARETE
Honed Bianco Carrara
Bianco Carrara Levigato

BASIN
LAVABO
Ninfa in Bianco Carrara

FLOATING SHELVES
VANI A GIORNO
Ciane in Bianco Carrara

This page
In questa pagina

WALL
PARETE
Gris du Marais Lithoverde®

FLOOR
PAVIMENTO
Honed Gris du Marais
Gris du Marais Levigato

BASIN
LAVABO
Ninfa in Gris du Marais

TABLE
TAVOLO
Dritto 40 x 40 in Pietra
d'Avola





WALL
PARETE
Tratti in Bianco Carrara

BASIN
LAVABO
Alfeo in Bianco Carrara

SIDE WALLS
PARETI LATERALI
Honed Crema d'Orcia
Crema d'Orcia Levigato

FACING WALL
PARETE FRONTALE
Crema d'Orcia Bamboo

BASIN AND DRAWERS
LAVABO E CASSETTI
Alfeo and Ciane in
Crema d'Orcia
Alfeo e Ciane in
Crema d'Orcia

MIRROR
SPECCHIO
Archimede Rectangle





WALL
PARETE
Honed Bianco Carrara
Bianco Carrara Levigato

BASIN
LAVABO
Alfeo in Bianco Carrara

MIRROR
SPECCHIO
Archimede Rectangle

WALL
PARETE
Pietra d'Avola Lithoverde®

BASIN
LAVABO
Ninfa in Pietra d'Avola

MIRROR
SPECCHIO
Archimede Circle

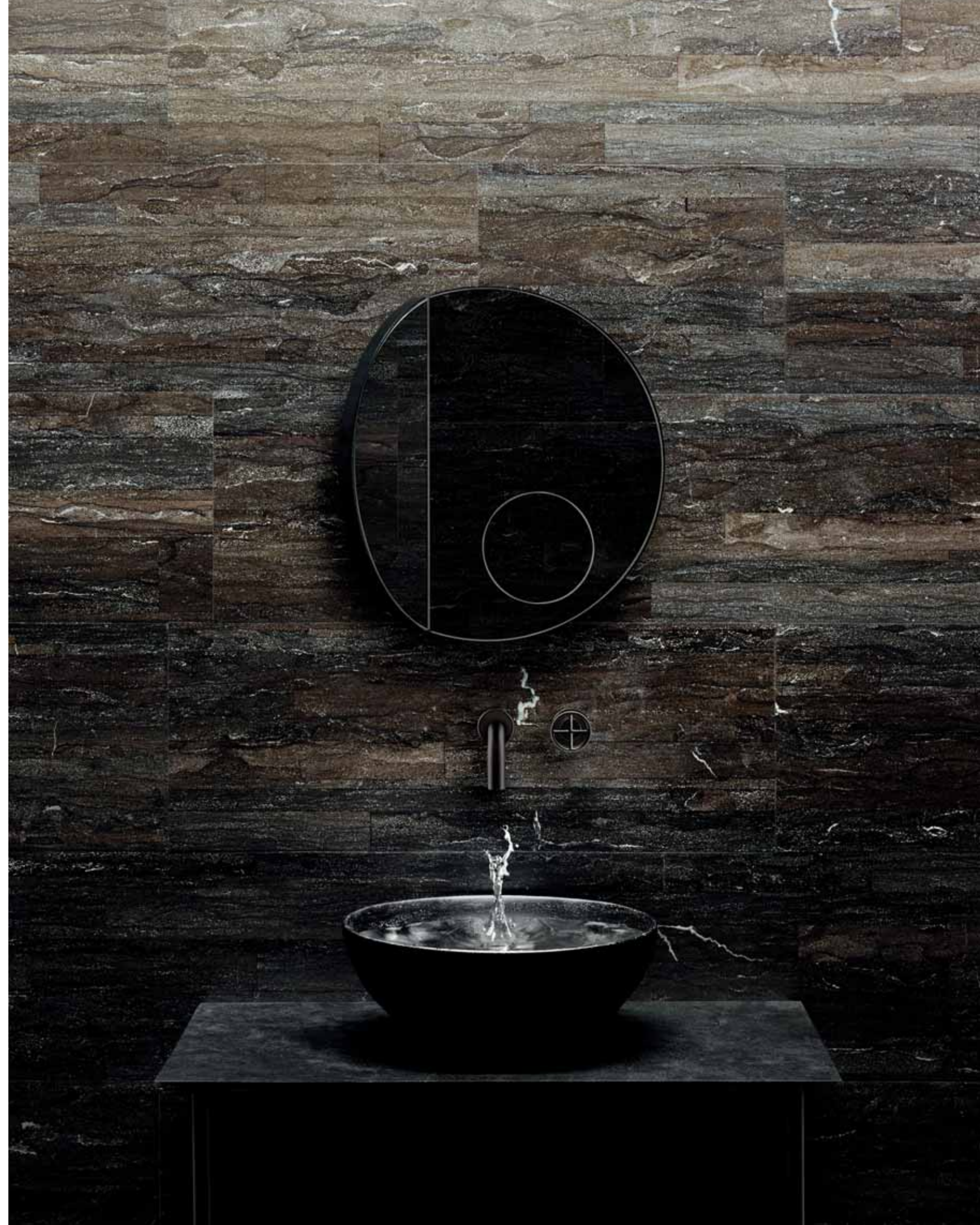

This page
In questa pagina

WALL
PARETE
Honed Gris du Marais
Gris du Marais Levigato

BASINS
LAVABI
Alfeo in Gris du Marais

DRAWERS
CASSETTI
Ciane in Gris du Marais

BATHTUB
VASCA
Oyster in Gris du Marais

MIRRORS
SPECCHI
Archimede Rectangle



Next page
Pagina successiva

WALL
PARETE
Crema d'Orcia Raw

BASIN AND MODULAR
DRAWERS
LAVABO E CASSETTI
COMPONIBILI
Alfeo and Ciane in
Crema d'Orcia
Alfeo e Ciane in
Crema d'Orcia

MIRROR
SPECCHIO
Archimede Circle

ACCESSORIES
ACCESSORI
Omaggio a Morandi
and PLAT-EAU
Omaggio a Morandi
e PLAT-EAU





Fontane Bianche Collection Fact Sheet Caratteristiche Tecniche

MATERIALS
MATERIALI

Bianco Carrara
Crema d'Orcia
Gris du Marais
Pietra d'Avola

Alfeo basin
Basin Alfeo

DIMENSIONS
DIMENSIONI

45 × 45 × 20 cm
17¾ × 17¾ × 7⅞"

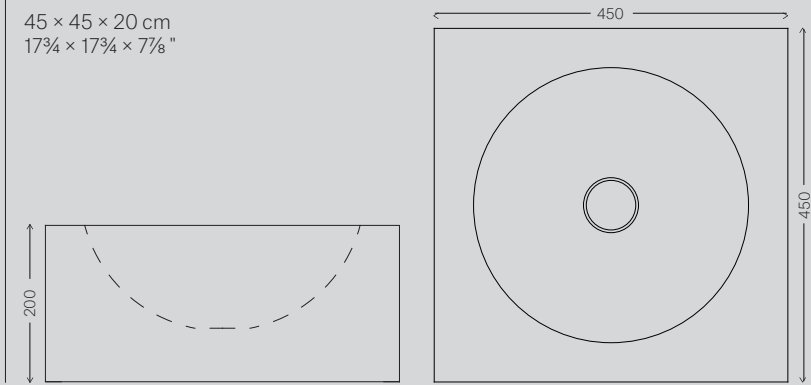

Ninfa basin
Lavabo Ninfa

DIMENSIONS
DIMENSIONI

80 × 45 × 90 cm
31½ × 17¾ × 35⅝"

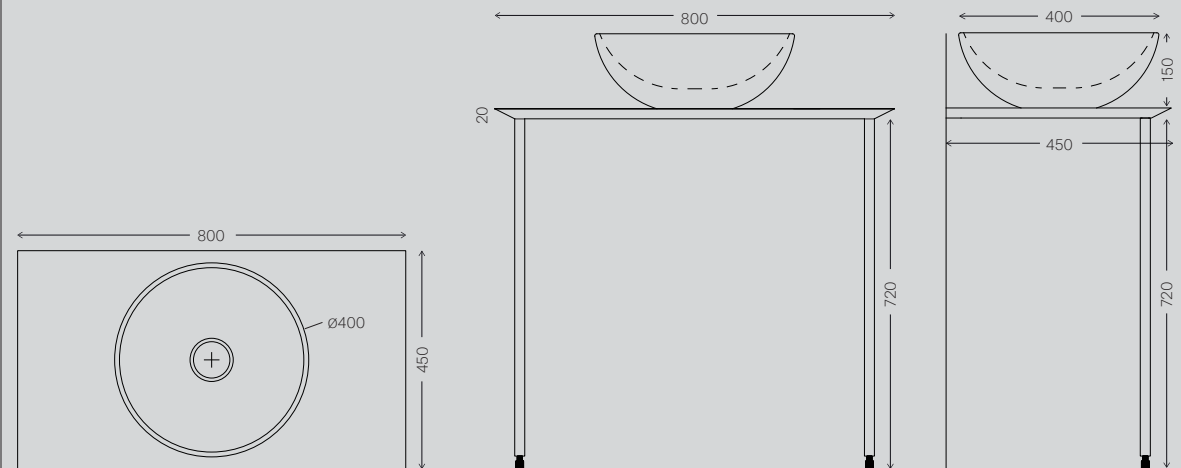

Ciane modular storage
Ciane cassette componibili

FLOATING SHELF
VANO A GIORNO

60 × 45 × 20 cm
23⅝ × 17¾ × 7⅞"

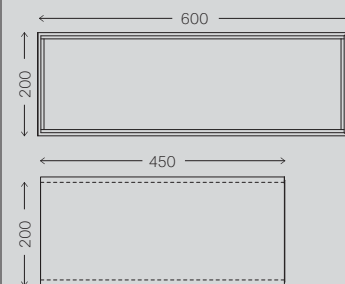

DRAWER
CASSETTO

60 × 45 × 20 cm
23⅝ × 17¾ × 7⅞"

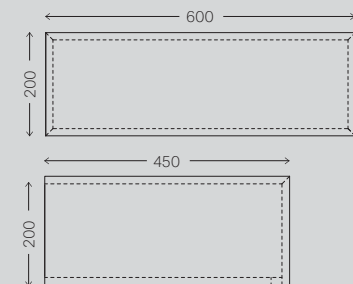

DRAWER
CASSETTO

90 × 45 × 20 cm
35⅝ × 17¾ × 7⅞"

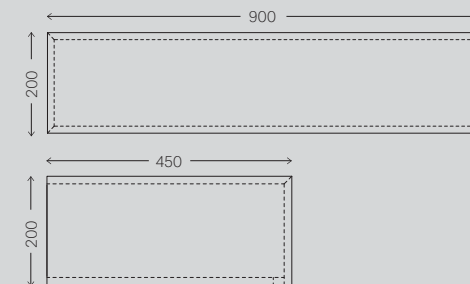

The Ciane series can be installed on their own or together with the Alfeo basin.
Available in Bianco Carrara, Pietra d'Avola, Gris du Marais and Crema d'Orcia.

La serie Ciane può essere installata singolarmente o insieme al lavabo Alfeo.
Disponibile in Bianco Carrara, Pietra d'Avola, Gris du Marais e Crema d'Orcia.

* Technical drawings in mm





"More than a design for a product, Onsen is a plan for a space. Starting from a basic material - marble - I developed a series of elements for the bathroom to create settings centred on the world of water and physical wellbeing." These are the words of Rodolfo Dordoni to describe his Onsen collection, characterised by its sharp clean lines, and whose name derives from the Japanese word for hot springs.

"Onsen, più che il progetto di un prodotto, è il progetto di un ambiente. Partendo dal materiale di base, il marmo, ho sviluppato una serie di elementi per la zona bagno che contribuiscono a creare ambienti legati al mondo dell' acqua e al benessere del corpo." Queste sono le parole usate da Rodolfo Dordoni per descrivere la sua collezione Onsen il cui nome deriva dal termine giapponese che identifica le sorgenti termali.

Onsen



WALL
PARETE
Honed Pietra d'Avola
Pietra d'Avola Levigato

FLOOR
PAVIMENTO
Sandblasted Pietra d'Avola
Pietra d'Avola Sabbiato

BASIN
LAVABO
Onsen Cabinet in
Pietra d'Avola
Onsen Mobile in
Pietra d'Avola

BATHTUB
VASCA
Onsen in Pietra d'Avola



Onsen Collection Fact Sheet Caratteristiche Tecniche

Basin with cabinet unit in lacquered wood
Lavabo con mobile in legno laccato

MATERIALS
MATERIALI

Bianco Carrara
Crema d'Orcia
Gris du Marais
Pietra d'Avola
Silk Georgette

DIMENSIONS
DIMENSIONI

120 × 40 × 55 cm
47¼ × 15¾ × 21¾"

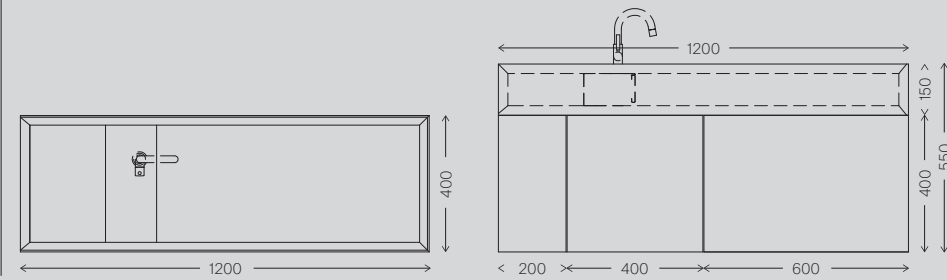

Basin on a stainless steel pedestal
Lavabo su colonna inox

DIMENSIONS
DIMENSIONI

120 × 40 × 85 cm
47¼ × 15¾ × 33½"

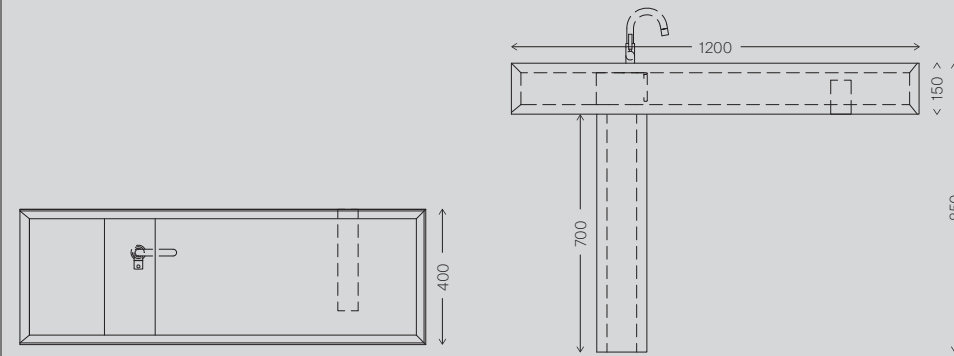

Bathtub
Vasca

DIMENSIONS
DIMENSIONI

180 × 80 × 53.5 cm
70¾ × 31½ × 21¾"

CAPACITY
CAPACITÀ

235 litres | litri
62 gallons

FLOW RATE
DEFUSSO SCARICO

48 litres/minute | litri/minuto
12½ gallons/minute

MAXIMUM WATER LEVEL
LIVELLO MASSIMO DELL'ACQUA

28 cm
11"

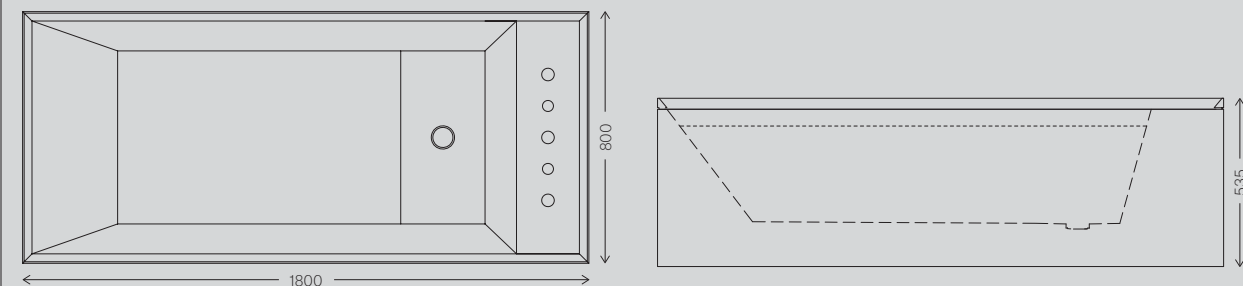

* Technical drawings in mm



WALL AND FLOOR
PARETE E PAVIMENTO
Honed Crema d'Orcia
Crema d'Orcia Levigato

BATHTUB
VASCA
Ishiburo in Crema d'Orcia



"I aspired to maximise the inherent material quality of stone. Being immersed in warm water contained within stone brings instinctive comfort to human beings".

These are the words of renowned architect and designer Kengo Kuma who, with Ishiburo, designed a collection which creates a truly harmonious and tranquil bathroom experience.

"Ho riflettuto sull'idea della pietra come materia e su come trarne beneficio. Custodita nella pietra, l'acqua calda dona sollievo a chi vi si immerge".

E' così che il famoso architetto e designer Kengo Kuma riassume il concetto alla base della collezione Ishiburo, pensata per creare una sensazione di totale armonia e relax.

Ishiburo Collection

WALLS AND FLOOR
PARETI E PAVIMENTO
Honed Crema d'Orcia
Crema d'Orcia Levigato

BASIN
LAVABO
Ishiburo in Crema d'Orcia

SHOWER WALL AND TRAY
PARETE E PIATTO DOCCIA
Ishiburo in Crema d'Orcia



WALL AND FLOOR
PARETE E PAVIMENTO
Honed Crema d'Orcia
Crema d'Orcia Levigato

BASIN LAVABO
Ishiburo in Crema d'Orcia



Ishiburo Collection Fact Sheet Caratteristiche Tecniche

Basin
Lavabo

MATERIALS
MATERIALI

Bianco Carrara
Crema d'Orcia
Pietra d'Avola
Silk Georgette

DIMENSIONS
DIMENSIONI

82.2 × 48.3 × 85 cm
32 3/4 × 19 × 33 1/2"



Bathtub
Vasca

DIMENSIONS
DIMENSIONI

203.5 × 100 × 55 cm
80 1/8 × 39 3/8 × 21 1/8"

CAPACITY
CAPACITÀ

400 litres | litri
105 1/2 gallons

FLOW RATE
DEFLUSSO SCARICO

48 litres/minute | litri/minuto
12 1/2 gallons/minute

MAXIMUM WATER LEVEL
LIVELLO MASSIMO DELL'ACQUA

30 cm
11 3/4"

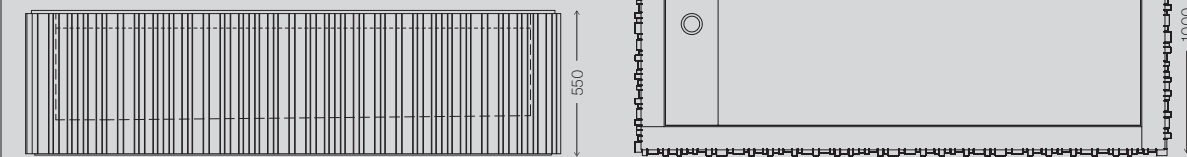

Shower tray
Piatto doccia

FEATURES
CARATTERISTICHE

Recycled teak slats laid over a stainless steel tray and encased in a natural stone frame.

Listelli in teak riciclato posati su un piatto in acciaio inox e incassati nella pietra.

DIMENSIONS
DIMENSIONI

159.8 × 108 × 8 cm
62 7/8 × 42 1/2 × 3 1/8"



Shower wall
Parete doccia

DIMENSIONS
DIMENSIONI

Comes in preassembled panels measuring 30.5 × 61 cm
12 × 24"

Disponibile in pannelli preassemblati di misura 30.5 × 61 cm
12 × 24"

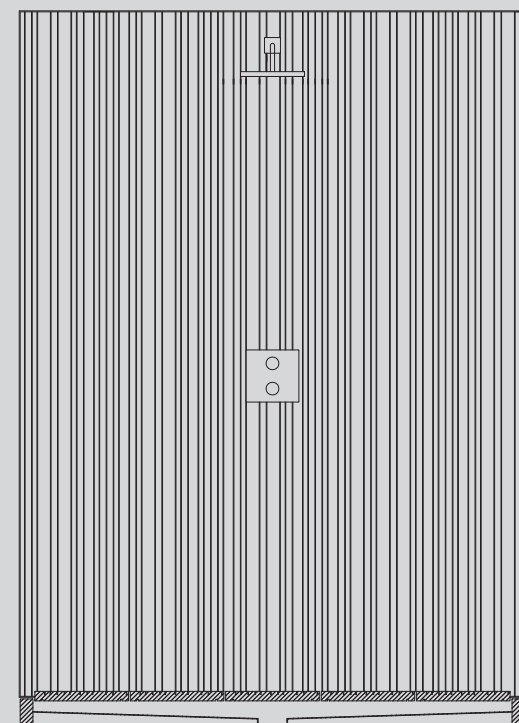
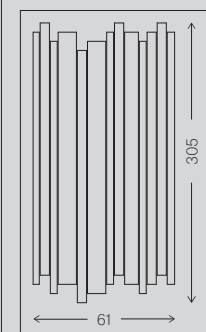

* Technical drawings in mm

BATHTUB
VASCA
Ishiburo in Crema d'Orcia





A basin in natural stone is perhaps the single element which can singlehandedly transform a bathroom, providing that "wow factor" or touch of elegance. In addition to the basins included in our Adda, Fontane Bianche, Onsen and Ishiburo collections, we also offer a range of countertop, wall-mounted and freestanding options. All our basins are designed with simplicity and flexibility in mind, together with ease of installation.

Un lavabo in pietra naturale è l'elemento che può trasformare un semplice bagno in qualcosa di unico, a condizione che integri contemporaneamente "il fattore wow" ed un tocco di innata eleganza. Oltre ai lavabi delle nostre collezioni Adda, Fontane Bianche, Onsen e Ishiburo, offriamo una ampia gamma di alternative sia per l'installazione a parete che freestanding. Tutti i nostri lavabi sono progettati sulla base di due concetti fondamentali: versatilità e facilità di installazione.

Basins Lavabi

WALL
PARETE
Bianco Carrara Rombico

BASIN
Stiletto in Bianco Carrara

MIRROR
SPECCHIO
Archimede Rectangle

ACCESSORIES
ACCESSORI
Fontane Bianche

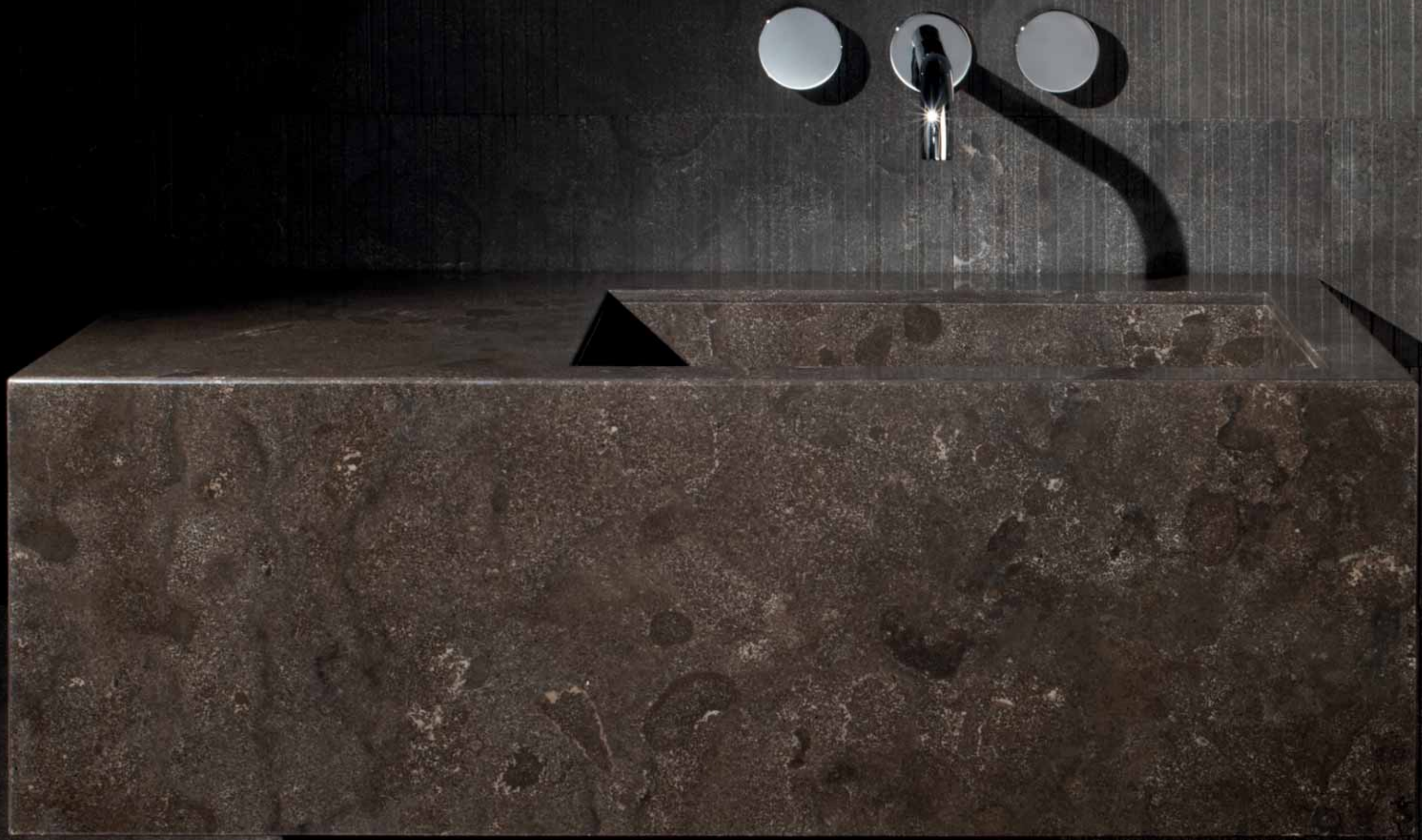



Previous spread
Pagina precedente

WALL
PARETE
Pietra d'Avola Raw

BASIN
LAVABO
Stiletto 90 in Pietra d'Avola

Facing page
In questa pagina

WALL
PARETE
Crema d'Orcia Infinito

BASIN
LAVABO
Stiletto 90 in Crema d'Orcia

MIRROR
SPECCHIO
Quadro

Accessories
Accessori
PLAT-EAU

WALL
PARETE
Silk Georgette Bamboo

FLOOR
PAVIMENTO
Honed Silk Georgette
Silk Georgette Levigato

BASIN
LAVABO
Stiletto 180 in Silk Georgette

ACCESSORIES
ACCESSORI
PLAT-EAU Bath





Pozzo



Zuppiera



Bacinella



Uovo



This page
In questa pagina

WALL
PARETE
Chevron in Crema d'Orcia

FLOOR
PAVIMENTO
Honed Crema d'Orcia
Crema d'Orcia Levigato

BASIN
LAVABO
Vasco Colonna
in Crema d'Orcia

MIRRORS
SPECCHI
Archimede Circle

Next page
Pagina successiva

WALL
PARETE
Chevron in Crema d'Orcia

BASIN
LAVABO
Vasco Colonna
in Crema d'Orcia



FACING WALL
PARETE FRONTALE
Silk Georgette Rombo

SIDE WALL AND FLOOR
PARETE LATERALE E
PAVIMENTO
Honed Silk Georgette
Silk Georgette Levigato

BASIN
LAVABO
Stiletto 180 in Silk Georgette

Next page
Pagina successiva

WALL AND FLOOR
PARETE E PAVIMENTO
Honed Lava
Lava Levigata

BASIN
LAVABO
Stiletto 180 in Lava

Basins Lavabi Fact Sheet Caratteristiche Tecniche

Stiletto

MATERIALS MATERIALI

Bianco Carrara
Crema d'Orcia
Gris du Marais
Lava
Pietra d'Avola
Silk Georgette

FEATURES CARATTERISTICHE

Every Stiletto basin comes complete with a high-flow waste, two wall brackets, high-performance Fischer screws, corresponding drill bit and spanner along with a template to aid alignment when drilling holes.
Taps can be wall- or deck-mounted, according to preference.

Ogni lavabo Stiletto è dotato di pilette di scarico ad alta portata, due staffe a muro, viti Fischer ad alte prestazioni, apposita punta per trapano e relativa chiave, unitamente a una dima per facilitare l'allineamento durante la fase di perforazione.
La rubinetteria può essere incassata o montata a parete in base alle preferenze.

STILETTO 90
90 × 50 × 30cm
35³/₈ × 19⁵/₈ × 11³/₈ "

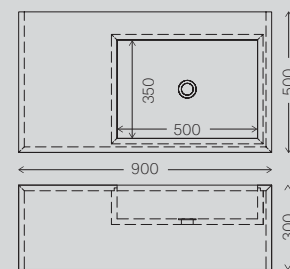

STILETTO 120
120 × 50 × 30cm
47¹/₄ × 19⁵/₈ × 11³/₈ "

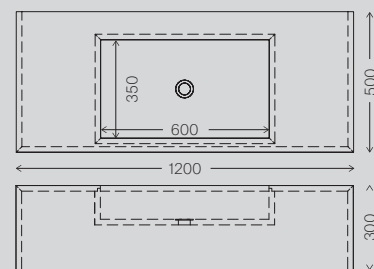

STILETTO 150
150 × 50 × 30cm
59 × 19⁵/₈ × 11³/₈ "

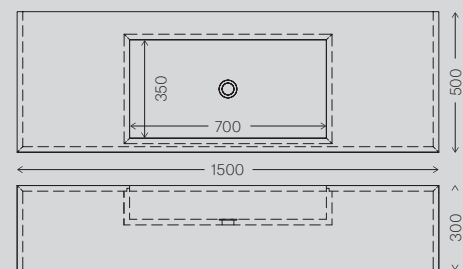

STILETTO 180
180 × 50 × 30cm
70⁷/₈ × 19⁵/₈ × 11³/₈ "

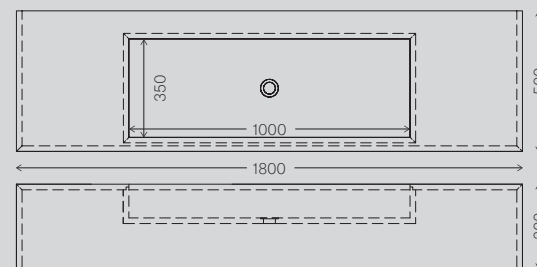

Countertop basins Lavabi da appoggio

MATERIALS MATERIALI

Bianco Carrara
Crema d'Orcia
Gris du Marais
Pietra d'Avola
Silk Georgette

POZZO
Ø46 × 20cm
Ø18¹/₈ × 7⁷/₈ "

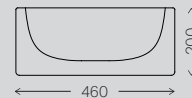

ZUPPIERA
Ø40 × 15cm
Ø15³/₄ × 5⁷/₈ "

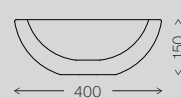

BACINELLA
Ø40 × 15cm
Ø15³/₄ × 5⁷/₈ "

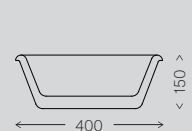

UOVO
Ø41.4 × 26.5cm
Ø16¹/₄ × 10³/₈ "

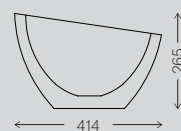

Vasco

MATERIALS MATERIALI

Bianco Carrara*
Crema d'Orcia*
Gris du Marais*
Lava

Pietra d'Avola*
Silk Georgette

*Also available
in Lithoverde®
Disponibile anche
in Lithoverde®

VASCO 40
40 × 40 × 15cm
15³/₄ × 15³/₄ × 5⁷/₈ "

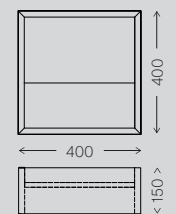

VASCO 60
40 × 60 × 15cm
15³/₄ × 23³/₈ × 5⁷/₈ "

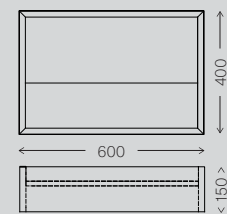

VASCO COLONNA 40
40 × 40 × 86cm
15³/₄ × 15³/₄ × 33³/₈ "

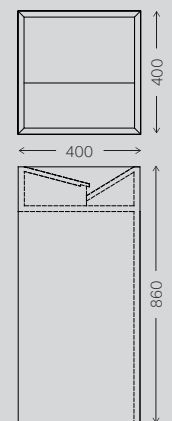

VASCO COLONNA 60
40 × 60 × 86cm
15³/₄ × 23³/₈ × 33³/₈ "

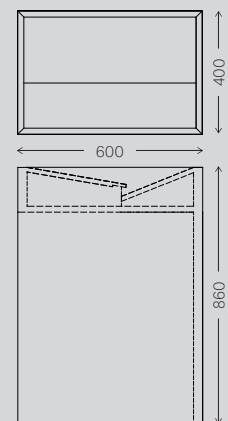

* Technical drawings in mm





Our shower trays are designed to be practical and supremely simple to install. Both our Ishiburo tray, included in the Ishiburo collection, and our popular Filo, utilise our revolutionary concept which we like to call Plug&Play simply because it really is that easy.

No carpenters, no stone cutters involved, each shower tray comes ready for a plumber to install with the minimum of fuss, thereby reducing time, cost and the stress of coordinating tradespeople.

Filo is available in six sizes in both a raised version and flush option in a choice of seven different natural stones and three finishes.

I nostri piatti doccia sono progettati per essere pratici e estremamente semplici da installare. Ogni elemento integra il nostro rivoluzionario concetto Plug&Play che consente la massima facilità di montaggio senza dover necessariamente coinvolgere muratori o marmisti. Basta il semplice intervento di un idraulico con conseguente riduzione di tempi, costi e difficoltà di coordinamento dei diversi operatori.

Filo è disponibile in 6 dimensioni sia in versione da appoggio che a filo pavimento con una scelta di sette diverse pietre naturali e tre finiture.

Shower Trays Piatti Doccia

Previous page
Pagina precedente

WALLS, FLOOR AND
CEILING
PARETI, PAVIMENTO E
SOFFITTO
Bianco Carrara Infinito

SHOWER TRAY
PIATTO DOCCIA
Filo 3 | 100 in Bianco
Carrara Cotone

Facing page
In questa pagina

FACING WALL
PARETE FRONTALE
Pietra d'Avola Lithoverde®

SIDE WALLS AND FLOOR
PARETI LATERALI E
PAVIMENTO
Honed Pietra d'Avola
Pietra d'Avola Levigato

SHOWER TRAY
PIATTO DOCCIA
Filo Flush 5 | 100 in
sandblasted Pietra d'Avola
Filo Flush 5 | 100 in Pietra
d'Avola sabbata

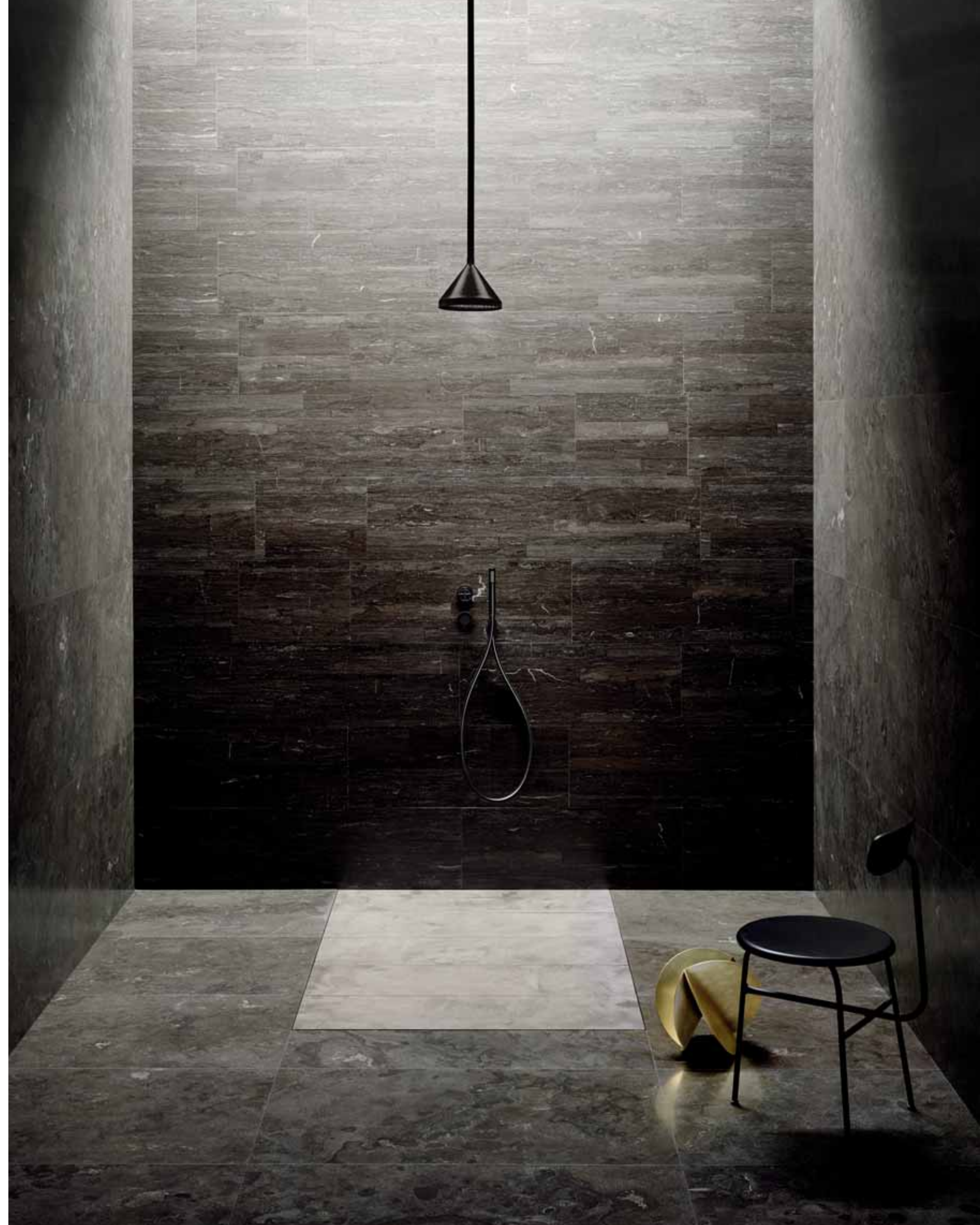

FLOOR
PAVIMENTO
Honed Bianco Carrara
Bianco Carrara Levigato

SHOWER TRAY
PIATTO DOCCIA
Filo Raised in Bianco
Carrara Bamboo

FLOOR
PAVIMENTO
Brushed sandblasted Lava
Lava Sabbia Spazzolata

SHOWER TRAY
PIATTO DOCCIA
Filo Flush 4180 in brushed
sandblasted Lava
Filo Flush 4180 in Lava
Sabbia Spazzolata



Previous page
Pagina precedente

FLOOR
PAVIMENTO
Honed Pietra d'Avola
Pietra d'Avola Levigato

SHOWER TRAYS
PIATTI DOCCIA
Filo Flush and Filo Raised
in Pietra d'Avola Raw
Filo Fush e Filo Raised
in Pietra d'Avola Raw

This page
In questa pagina

FLOOR
PAVIMENTO
Honed Crema d'Orcia
Crema d'Orcia Levigato

SHOWER TRAYS
PIATTI DOCCIA
Filo Flush and Filo Raised in
Crema d'Orcia Raw
Filo Flush e Filo Raised in
Crema d'Orcia Raw





WALL AND FLOOR
PARETE E PAVIMENTO
Bianco Carrara Infinito

SHOWER TRAY
PIATTO DOCCIA
Filo 3 | 100 in Bianco
Carrara Cotone



FLOOR
PAVIMENTO
Honed Silk Georgette
Silk Georgette Levigato

SHOWER TRAY
PIATTO DOCCIA
Filo Flush in Silk Georgette
Bamboo



REAR WALL
PARETE FRONTALE
Honed Pietra d'Avola
Pietra d'Avola Levigato

SHOWER WALL AND
FLOOR
Sandblasted Pietra d'Avola
Pietra d'Avola Sabbiato

SHOWER TRAY
PIATTO DOCCIA
Filo Raised 3 | 88 in Pietra
d'Avola Raw



WALL
PARETE
Pietra d'Avola Raw

FLOOR
PAVIMENTO
Honed Pietra d'Avola
Pietra d'Avola Levigato

SHOWER TRAY
PIATTO DOCCIA
Filo Flush 4|100 in Pietra
d'Avola Raw

Shower Trays

Piatti Doccia

Fact Sheet

Caratteristiche

Tecniche

Filo Flush
Filo versione a filo pavimento

MATERIALS
MATERIALI

Bianco Carrara
Crema d'Orcia
Gris du Marais
Lava
Pietra d'Avola
Piombo
Silk Georgette

TEXTURES*
FINITURE

Bamboo
Raw
Sandblasted | Sabbiato

* Lava and Piombo available only in

Lava e Piombo disponibili solo con
finitura Sabbziata, Gris du Marais in
finitura Cotone

FEATURES
CARATTERISTICHE

Every Filo shower tray comes complete with a self-cleaning waste (flow rate 33 lt [8.7 gal] /min) for instant attachment to existing systems and a stainless steel tray edged with rubber to minimise noise and slippage. Included in the kit are silicone sealant, rubber strips and a customised lever for raising the slats when particularly thorough cleaning is required.

Ogni piatto doccia Filo viene fornito con piletta e sistema autopulente (portata di scarico 33 lt/min) per un facile collegamento agli scarichi oltre a guarnizione in gomma per aumentare l'insonorizzazione e l'aderenza. Nel kit sono compresi: sigillante siliconico, canaletta in gomma e leva personalizzata per sollevare le doghe quando è necessaria una pulizia profonda.

Filo 3 | 80
90 × 80 cm
35½ × 31½"

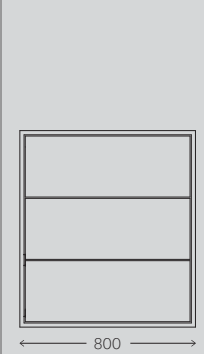

Filo 4 | 80
119.8 × 80 cm
47¼ × 31½"

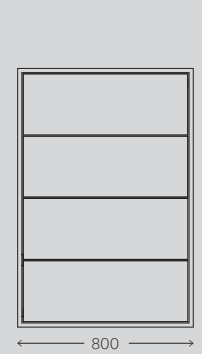

Filo 5 | 80
149.6 × 80 cm
58¾ × 31½"

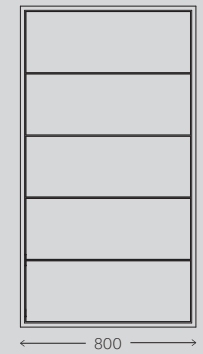

Filo 3 | 100
90 × 100 cm
35½ × 39¾"

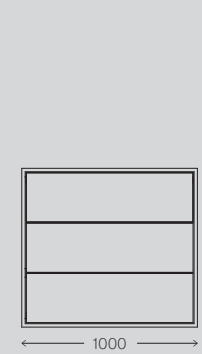

Filo 4 | 100
119.8 × 100 cm
47¼ × 39¾"

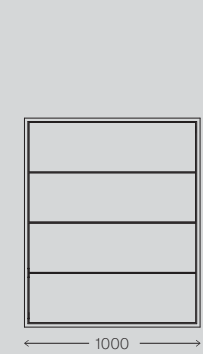

Filo 5 | 100
149.6 × 100 cm
58¾ × 39¾"



Filo Raised
Filo versione da appoggio

FILO 3 | 88
98 × 88cm
38¾ × 34¾"

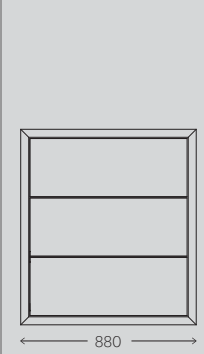

FILO 4 | 88
127.8 × 88cm
50¼ × 34¾"

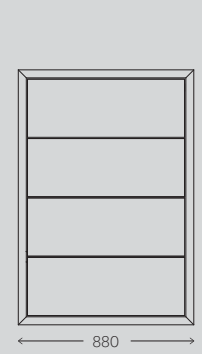

FILO 5 | 88
157.6 × 88cm
62 × 34¾"

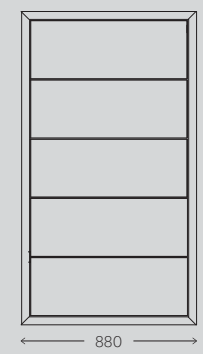

FILO 3 | 108
98 × 108cm
38¾ × 42½"

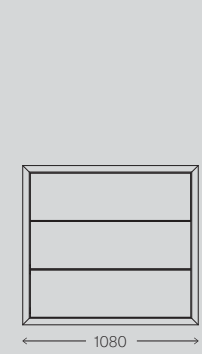

FILO 4 | 108
127.8 × 108cm
50¼ × 42½"

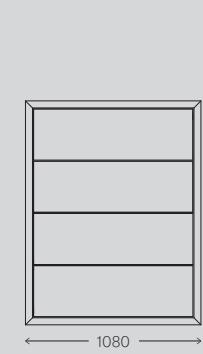

FILO 5 | 108
157.6 × 108cm
62 × 42½"

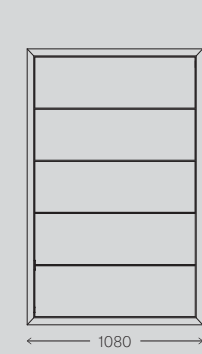

EASY CLEANING
FACILE DA PULIRE

For occasional more intensive cleaning such as the removal of hair from the plug hole, the slats of the Filo shower tray can be easily lifted using the customised lever provided.

Per la pulizia straordinaria del piatto doccia come la rimozione dei capelli dallo scarico, le lastre del piatto doccia Filo possono essere facilmente sollevate usando l'apposita chiave che viene fornita all'interno della confezione di vendita.

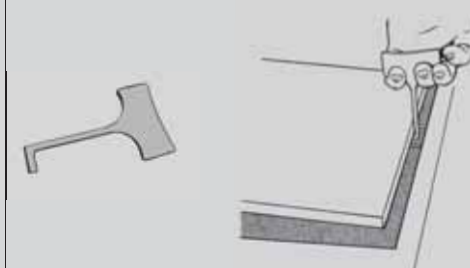

WALL AND FLOOR
PARETE E PAVIMENTO
Piombo

SHOWER TRAY
PIATTO DOCCIA
Filo Raised 5 | 108 in
sandblasted Piombo
Filo Raised 5 | 108 in
Piombo sabbiato



* Technical drawings in mm

WALLS
PARETI
Bianco Carrara Lithoverde®

FLOOR
PAVIMENTO
Honed Bianco Carrara
Bianco Carrara Levigato

BATHTUB
VASCA
Oyster

TABLE
TAVOLO
Dritto

LAMP
LAMPADA
Urano 18

DECORATIVE BOTTLE
BOTTIGLIA
Omaggio a Morandi in
Rosa Perlino



As with all our products, our bathtubs are designed with simplicity and ease of installation in mind. Our range of bathtubs currently includes Ishiburo and Onsen, details of which can be found in the relevant collections, and Oyster.

Completely wrapped in natural stone, the Oyster bathtub could be described as a "design your own tub".

With its beautifully simple structure, clean lines and 16 possible combinations of finish, it's the perfect starting point for a Total Look stone bathroom.

Così come ogni nostro prodotto, le nostre vasche da bagno sono progettate tenendo ben presente la semplicità e facilità di installazione. La nostra gamma di vasche da bagno attualmente comprende Ishiburo, Onsen e Oyster.

Completamente rivestita in pietra naturale, Oyster ti dà la possibilità di "progettare la tua vasca da bagno personalizzata".

Il design è sobrio ed elegante e caratterizzato da linee asciutte; Oyster è disponibile in 16 possibili combinazioni di finitura e rappresenta il punto di partenza per una soluzione "total look" dell'ambiente bagno in pietra naturale.

Bathtubs Vasche

REAR WALL
PARETE FRONTALE
Crema d'Orcia Raw

SIDE WALLS AND FLOOR
PARETI LATERALI E
PAVIMENTO
Honed Crema d'Orcia
Crema d'Orcia Levigato

BATHTUB
VASCA
Oyster in Crema d'Orcia Raw



WALLS
PARETI
Bianco Carrara Lithoverde®

BATHTUB
VASCA
Oyster in Bianco Carrara



Bathtubs
Vasche
Fact Sheet
Caratteristiche
Tecniche

Oyster

MATERIALS MATERIALI

Bianco Carrara
Crema d'Orcia
Pietra d'Avola
Silk Georgette

TEXTURES FINITURE

Honed | levigato
Bamboo
Infinito
Raw

FEATURES CARATTERISTICHE

The Oyster bathtub is compatible with both wall-mounted and freestanding tapware. Should you require an access panel for inspection, please specify on which side when you place your order.

La vasca Oyster è predisposta per l'utilizzo di rubinetterie free standing o a parete. Se avete bisogno di un pannello di accesso per le ispezioni, vi preghiamo di precisare il lato desiderato al momento dell'ordine.

DIMENSIONS DIMENSIONI

180 × 80 × 51.5 cm
70⁷/₈ × 31¹/₂ × 20¹/₄ "

CAPACITY CAPACITÀ

216 litres | litri
57 gallons

FLOW RATE DEFLUSSO SCARICO

48 litres/minute | litri/minuto
12¹/₂ gallons/minute

MAXIMUM WATER LEVEL LIVELLO MASSIMO DELL'ACQUA

28 cm
11"

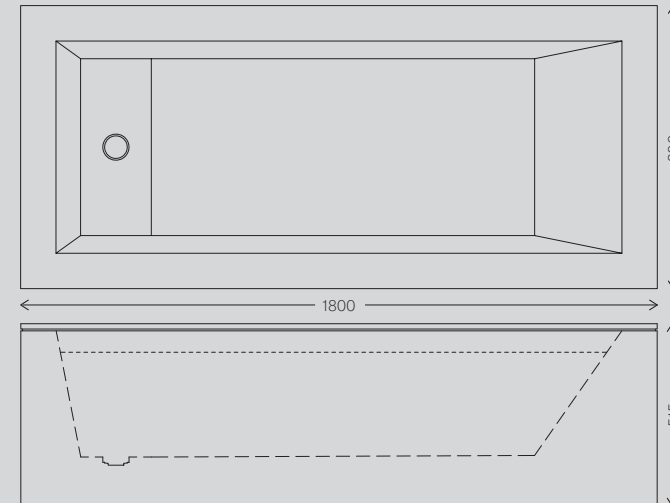

REAR WALL
PARETE FRONTALE
Crema d'Orcia Raw

FLOOR
PAVIMENTO
Honed Crema d'Orcia
Crema d'Orcia Levigato

BATH
VASCA
Oyster in Crema d'Orcia Raw



WALL
PARETE
Honed Bianco Carrara
Bianco Carrara Levigato

BASIN
LAVABO
Alfeo in Bianco Carrara

MODULAR DRAWER
CASSETTO
COMPONIBILE
Ciane

ACCESSORIES
ACCESSORI
Fontane Bianche

MIRROR
SPECCHIO
Archimede Rectangle

The delicate touch and bold geometric forms that characterise the Fontane Bianche collection of basins and tapware continue in the new range of accessories created by Elisa Ossino together with Salvatori.

Comprising towel rings, wall hooks, a table mirror and a series of modular trays and bathroom receptacles in natural stone, each item is hand finished and reflects both the simplicity which is the hallmark of Elisa's approach to design and the attention to detail for which Salvatori are known the world over.

Il tocco delicato e le audaci forme geometriche che caratterizzano la collezione di lavandini e rubinetti Fontane Bianche rivive nella nuova serie di accessori creati da Elisa Ossino per Salvatori.

La serie è composta da portasciugamani, appendiabiti, specchio da tavolo, una gamma di vassoi modulari, un portasapone e dei portaspazzolini in pietra naturale. Ogni articolo è rifinito a mano e riflette la semplicità che costituisce l'elemento caratterizzante dell'approccio di Elisa Ossino verso il design e l'attenzione per i dettagli grazie alla quale Salvatori è riconosciuta in tutto il mondo.

Fontane Bianche Accessories Accessori

WALL AND COUNTERTOP
PARETE E PIANO
Honed Bianco Carrara
Bianco Carrara Levigato

SOAP DISH, TUMBLER
AND TOOTHBRUSH
HOLDER
PORTASAPONE E
PORTASPAZZOLINI
Fontane Bianche in Bianco
Carrara

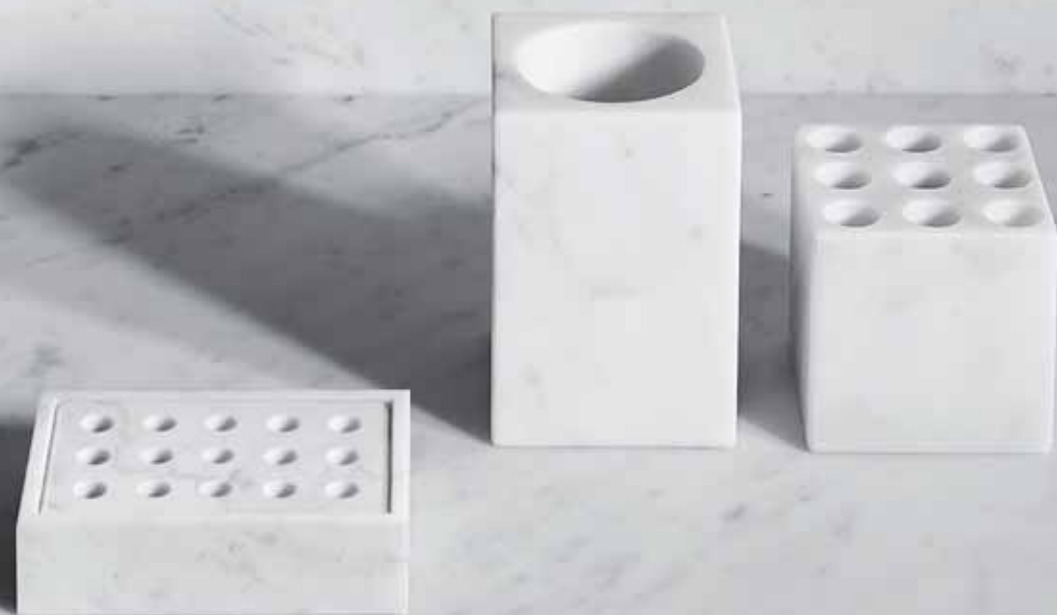

WALL AND COUNTERTOP
PARETE E PIANO
Honed Bianco Carrara
Bianco Carrara Levigato

TABLE MIRROR
SPECCHIO DA TAVOLO
Fontane Bianche in Bianco
Carrara



WALL
PARETE
Honed Bianco Carrara
Bianco Carrara Levigato

TOWEL RING
PORTASCIUGAMANI
Fontane Bianche in Bianco
Carrara



Fontane
Bianche
Accessories
Accessori
Fact Sheet
Caratteristiche
Tecniche

Soap dish
Portasapone

MATERIALS
MATERIALI

Bianco Carrara
Pietra d'Avola

DIMENSIONS
DIMENSIONI

8 × 12 × 3 cm
3 1/8 × 4 3/4 × 1 1/4"

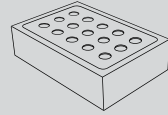

Tumbler
Portaspazzolini 01

MATERIALS
MATERIALI

Bianco Carrara
Pietra d'Avola

DIMENSIONS
DIMENSIONI

8 × 8 × 12 cm
3 1/8 × 3 1/8 × 4 3/4"

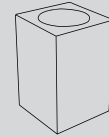

Toothbrush holder
Portaspazzolini 02

MATERIALS
MATERIALI

Bianco Carrara
Pietra d'Avola

DIMENSIONS
DIMENSIONI

8 × 8 × 8 cm
3 1/8 × 3 1/8 × 3 1/8"

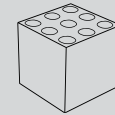

Wall hooks
Appendiabiti

MATERIALS
MATERIALI

Bianco Carrara
Botticino
Verde Alpi
Gris du Marais

DIMENSIONS
DIMENSIONI

Ø7 × 4 cm
Ø2 3/4 × 1 5/8"



Ø9 × 8 cm
Ø3 1/2 × 3 1/8"



Ø12 × 11 cm
Ø4 3/4 × 4 3/8"

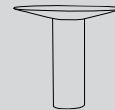

Table mirror
Specchio da tavolo

MATERIALS
MATERIALI

Bianco Carrara
Pietra d'Avola

DIMENSIONS
DIMENSIONI

Ø10 × 31 cm
Ø4 × 12 1/4"

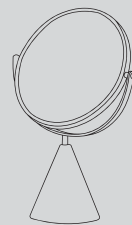

Towel ring
Portasciugamani

MATERIALS
MATERIALI

Bianco Carrara
Pietra d'Avola

DIMENSIONS
DIMENSIONI

Ø24 × 8 cm
Ø9 1/2 × 3 1/8"

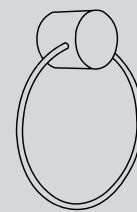

Modular trays
Vassoi componibili

MATERIALS
MATERIALI

Bianco Carrara
Pietra d'Avola

DIMENSIONS
DIMENSIONI

20 × 20 × 3 cm
7 7/8 × 7 7/8 × 1 1/4"



15 × 5 × 3 cm
5 7/8 × 2 × 1 1/4"

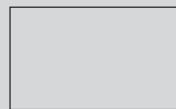

10 × 20 × 3 cm
3 7/8 × 7 7/8 × 1 1/4"



15 × 15 × 3 cm
5 7/8 × 5 7/8 × 1 1/4"



WALL HOOKS
APPENDIABITI
Bianco Carrara





Sometimes all you need is just a tiny element of luxury to add the finishing touch to a room. Our PLAT-EAU collection by Silvia Fanticelli includes accessories for the bathroom created from natural stone and brass crafted by Tuscan artists.

A volte, per dare il tocco finale ad una stanza, basta un piccolo oggetto di lusso. La nostra collezione PLAT-EAU disegnata da Silvia Fanticelli include complementi di arredo per il bagno, prodotti in pietra naturale in abbinamento a ottone e rifiniti a mano dai nostri artigiani in Toscana.

PLAT-EAU



Previous page
Pagina precedente

WALL
PARETE
Gris du Marais Lithoverde®

TOOTHBRUSH HOLDER
PORTASPAZZOLINI
PLAT-EAU Bath 01
in Pietra d'Avola

TRAY
VASSOIO
PLAT-EAU Classic 01

WALL
PARETE
Gris du Marais Lithoverde®

BASIN
LAVABO
Stiletto 180 in Gris du Marais

TUMBLER
PORTASPAZZOLINI
PLAT-EAU Bath 04

SOAP DISH
PORTASAPONE
PLAT-EAU Bath 03

TRAY
VASSOIO
PLAT-EAU Classic 01

Next page
Pagina successiva

WALL
PARETE
Pietra d'Avola Raw

BASIN
LAVABO
Stiletto 90 in Pietra d'Avola

TOOTHBRUSH HOLDER
PORTASPAZZOLINI
PLAT-EAU Bath 02

TRAY
VASSOIO
PLAT-EAU Classic 02



PLAT-EAU

Fact Sheet

Caratteristiche

Tecniche

WALL
PARETE
Silk Georgette Bamboo

BASIN
LAVABO
Stiletto 180 in Silk Georgette

TUMBLER
PORTASPAZZOLINI
PLAT-EAU Bath 04

TRAY
VASSOIO
PLAT-EAU Classic 01

Bath 01

MATERIALS
MATERIALI
Bianco Carrara
Pietra d'Avola

DIMENSIONS
DIMENSIONI
15 × 11 × 4 cm
6 × 4³/₈ × 2³/₄"

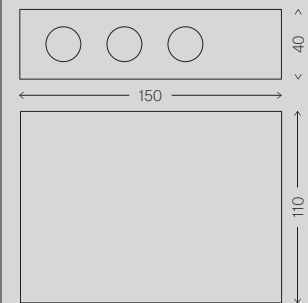

Bath 02

MATERIALS
MATERIALI
Brass with base
in Pietra d'Avola
-
Ottone e base
di appoggio in
Pietra d'Avola

DIMENSIONS
DIMENSIONI
17 × 11 × 3 cm
6³/₄ × 4³/₈ × 1¹/₄"

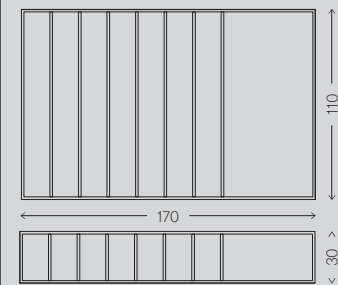

Bath 03

MATERIALS
MATERIALI
Brass with base
in Pietra d'Avola
-
Ottone e base
di appoggio in
Pietra d'Avola

DIMENSIONS
DIMENSIONI
11 × 6 × 3 cm
4³/₈ × 2³/₈ × 1¹/₄"

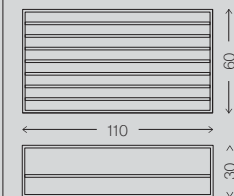

Bath 04

MATERIALS
MATERIALI
Brass with base in Pietra d'Avola
-
Ottone e base di appoggio in Pietra d'Avola

DIMENSIONS
DIMENSIONI
Ø7.5 × 10 cm
Ø3 × 4"

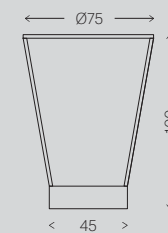

Classic 01

MATERIALS
MATERIALI
Bianco Carrara Raw, Pietra d'Avola
in honed and Bamboo textures with
brass frame
-
Bianco Carrara Raw, Pietra d'Avola
Levigato e Bamboo con struttura
in ottone

MAXIMUM DIMENSIONS
DIMENSIONI MASSIME
37 × 30 × 3 cm
14¹/₂ × 11³/₈ × 1¹/₄"

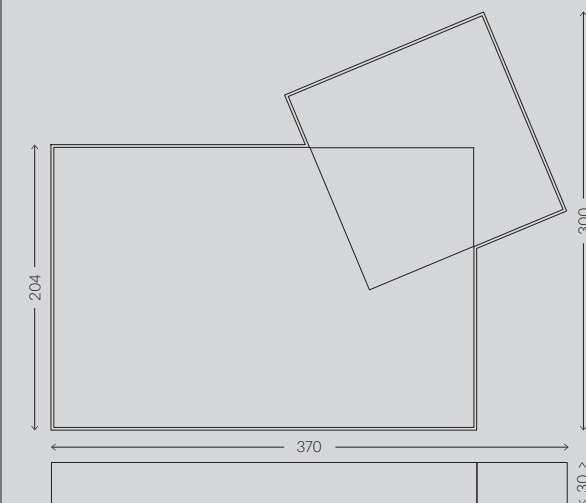

Classic 02

MATERIALS
MATERIALI
Pietra d'Avola Bamboo framed
in brass with container
in Bianco Carrara
-
Pietra d'Avola Bamboo con
struttura in ottone e contenitore
in Bianco Carrara

MAXIMUM DIMENSIONS
DIMENSIONI MASSIME
37 × 27 × 7 cm
14¹/₂ × 10⁵/₈ × 2³/₄"

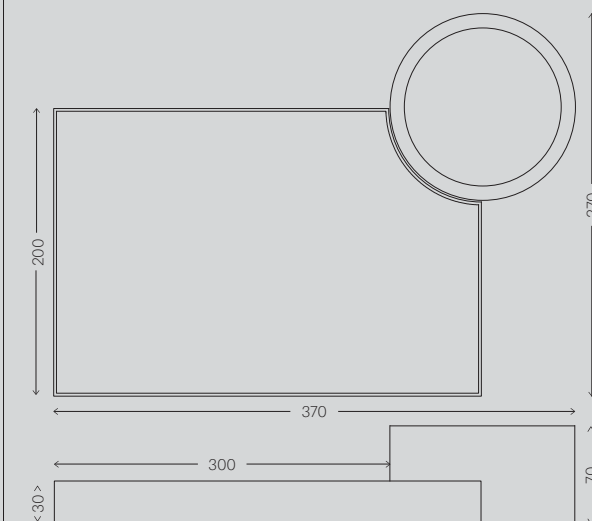

* Technical drawings in mm





WALL
PARETE
Bianco Carrara Romboo

MIRROR
SPECCHIO
Archimede Rectangle

BASIN
LAVABO
Stiletto 120

ACCESSORIES
ACCESSORI
PLAT-EAU Bath

Installation & Care Installazione e Manutenzione

Easy Installation Semplice da Installare

FILO FLUSH FILO VERSIONE A FILO PAVIMENTO

Prepare your mortar bed in the usual way.

STEP 1
Position the stainless steel tray.

STEP 2
Connect the waste.

STEP 3
Lay the slats onto the tray.

Preparare il sottofondo cementizio e il tubo di scarico come di consueto

FASE 1
Posizionare il piatto in acciaio inox.

FASE 2
Collegare la piletta al sistema di tubazione.

FASE 3
Procedere alla posa delle doghe sul piatto.

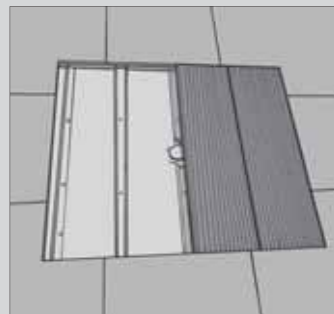
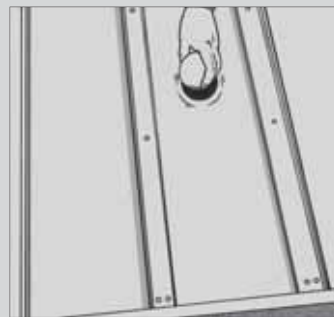
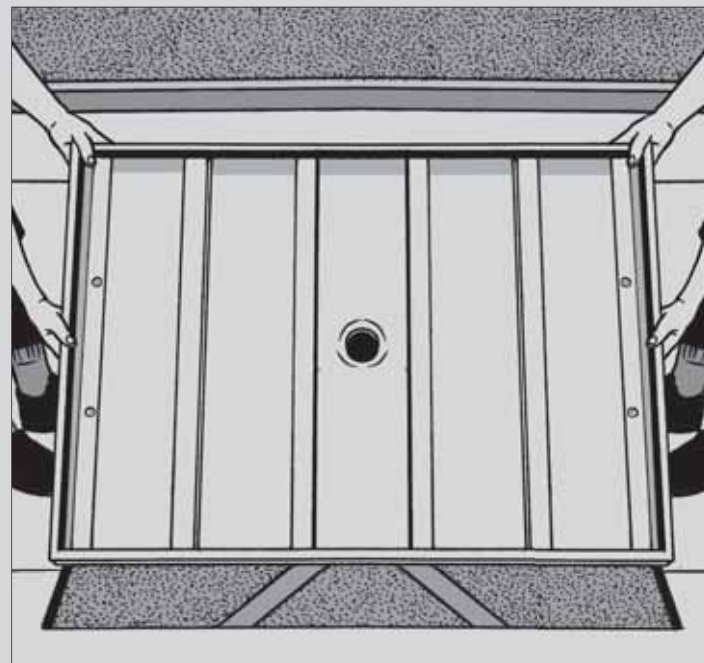

FILO RAISED FILO VERSIONE DA APPOGGIO

Prepare the ground in the normal manner, paving or covering the floor.

STEP 1
Insert the waste provided in the Filo kit over the hole and connect to the existing pipe system.

STEP 2
Place the steel tray over the waste.

STEP 3
Lay the slats onto the tray.

Preparare il fondo come di consueto, piastrellando o coprendo il pavimento.

FASE 1
Inserire la piletta in dotazione nel kit Filo attraverso il foro e collegarla al sistema di tubazione.

FASE 2
Posizionare il piatto in acciaio sopra la piletta.

FASE 3
Procedere alla posa delle doghe sul piatto.

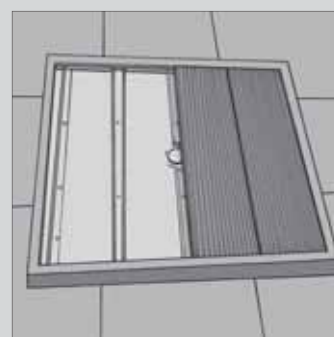
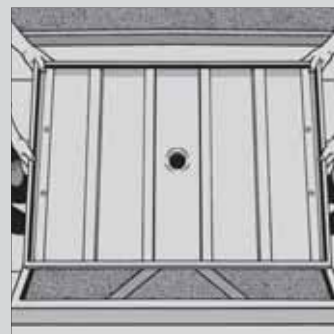
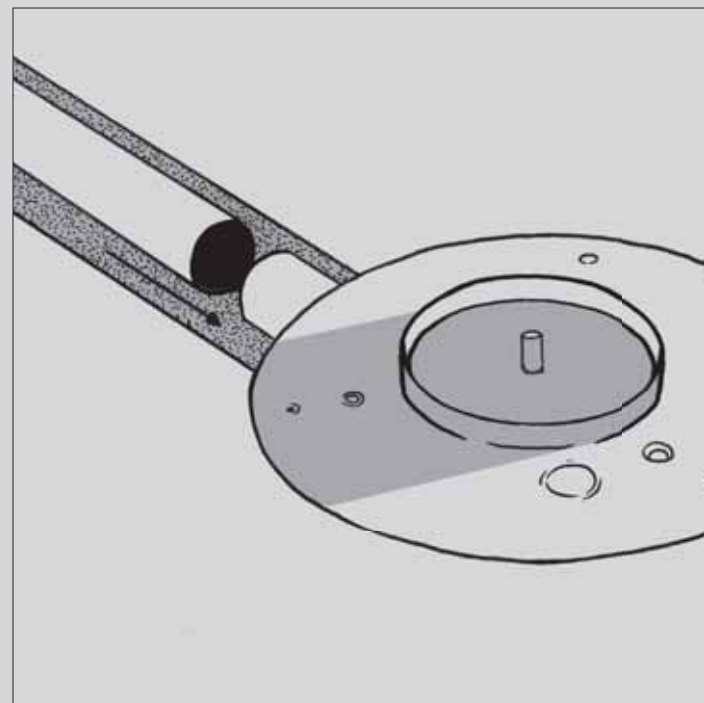

Sketches are for illustrative purposes only

Easy Installation Semplice da Installare

STILETTO

STEP 1
Attach the two brackets supplied in the Stiletto kit to the wall.

STEP 2
Place the basin onto the brackets.

STEP 3
Connect the pipe.

FASE 1
Applicare alla parete le due staffe in dotazione nel kit Stiletto.

FASE 2
Posizionare il lavabo sulle staffe.

FASE 3
Collegare la tubatura.

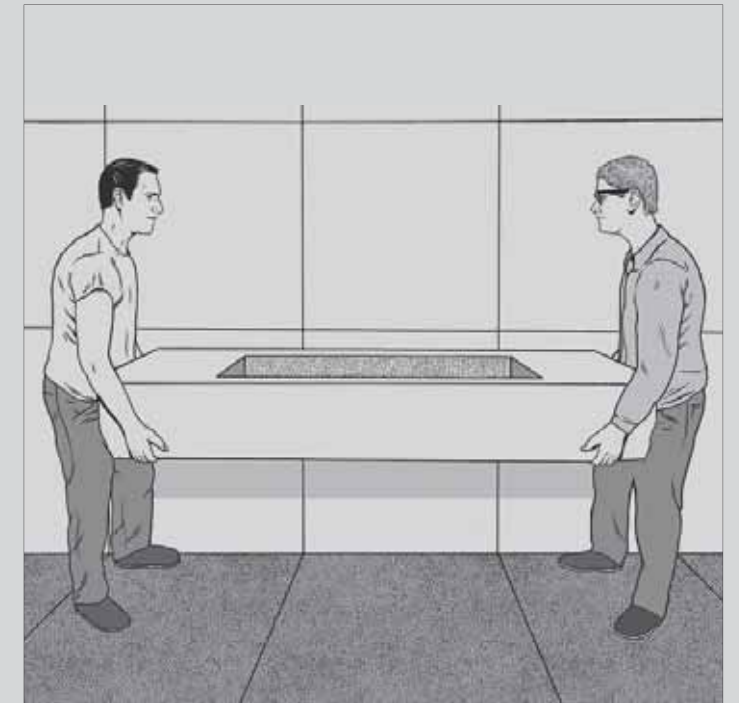
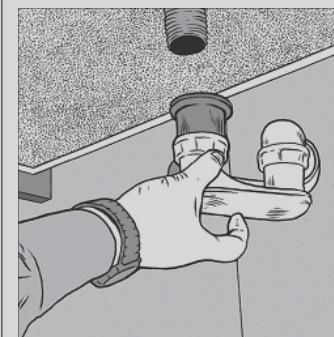
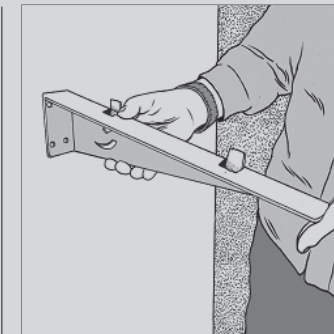

How to look after your Salvatori bathroom Come prendersi cura di un bagno Salvatori

Caring for shower trays, basins and baths made from stone generally requires no more effort than for those manufactured from porcelain or plastic. The key, as for other materials, is to clean regularly so that soap scum, lime scale and the like do not have the chance to build up and congeal as that is when it becomes difficult to remove completely.

Stone floors and walls simply need to be wiped down using a neutral cleaner. One of the great properties of stone is that it stands up to hard wear and tear, so if you have grooved surfaces such as our Bamboo or Raw textures, you can use a scrubbing brush without fear of causing damage.

For occasional more intensive cleaning such as the removal of hair from the plug hole, the slats of the Filo shower tray can be easily lifted using the customised lever provided.

And to really ensure you keep your stone looking beautiful for years, we strongly recommend that you do not use cleaners containing abrasive cleansers, ammonia, bleach, acid or other strong solvents. Even those trusty "homemade remedies" made from lemon, vinegar, baking soda and the like should be avoided.

Every bathtub, basin and shower tray that leaves Salvatori is treated with a protective sealer designed to repel water and oil-based stains.

For any other questions you may have please feel free to email our Customer Care team at customer-care@salvatori.it.

La pulizia e la manutenzione dei nostri piatti doccia, lavabi e vasche in pietra è semplice come quella per gli stessi oggetti realizzati in porcellana o plastica. Come per qualsiasi altro materiale, i prodotti Salvatori devono essere puliti regolarmente per evitare l'accumulo di residui di sapone, calcare e simili che, diversamente, diventerebbe difficile da rimuovere completamente.

Per la pulizia dei pavimenti e delle pareti in pietra è sufficiente l'impiego di un detergente neutro. Una delle proprietà della pietra più apprezzate è la sua resistenza all'usura, pertanto, se avete superfici con finiture nelle versioni Bamboo o Raw, potete utilizzare tranquillamente una spazzola con setole dure senza alcun timore di causare eventuali danni.

Per una detersione più profonda e occasionale, come ad esempio la rimozione di capelli dallo scarico del piatto doccia Filo, è possibile sollevare le doghe utilizzando l'apposita leva in dotazione.

Inoltre, se volete mantenere a lungo la bellezza delle pietre, raccomandiamo vivamente di non utilizzare detergenti contenenti sostanze abrasive, ammoniaca, candeggina, acido o altri solventi aggressivi. Evitare inoltre eventuali rimedi "casalinghi" a base di limone, aceto, bicarbonato e simili.

Ogni vasca da bagno, lavabo e piatto doccia fornito da Salvatori è trattato con un prodotto olio idro repellente.

Per qualsiasi domanda o chiarimento, non esitate a inviarci una e-mail all'indirizzo customer-care@salvatori.it

CREDITS

Graphic design: Kuchar Swara and Ling Ko
Interior design and styling: Elisa Ossino Studio
Photography: Kasia Gatkowska, Michael Bodiam
Tommaso Sartori, Dario Tettamanzi Gabriele
Salvatori, Fabrizio Palla
Illustrations: Louise Zergaeng Pomeroy

THANKS TO

Boffi
Fantini Rubinetti
Henry Timi
Laboratorio di Scultura Cervietti Pietrasanta

TAPWARE

The taps in midnight black used in this catalogue
belong to the Fontane Bianche collection by
Salvatori + Fantini.

Tapware in matt steel are from the Aboutwater
collection by Boffi + Fantini.

For a complete and current list of stockists please
contact customercare@salvatori.it or visit the
Find A Dealer area of our website.

salvatori.it

RINGRAZIAMENTI

Graphic design: Kuchar Swara e Ling Ko
Interior design e styling: Elisa Ossino Studio
Fotografia: Kasia Gatkowska, Michael Bodiam
Tommaso Sartori, Dario Tettamanzi Gabriele
Salvatori, Fabrizio Palla
Illustrazioni: Louise Zergaeng Pomeroy

SI RINGRAZIANO

Boffi
Fantini Rubinetti
Henry Timi
Laboratorio di Scultura Cervietti Pietrasanta

RUBINETTERIE

Le rubinetterie in acciaio midnight black presenti
nel catalogo appartengono alla collezione Fontane
Bianche di Salvatori+Fantini.

Le rubinetterie in acciaio satinato appartengono
alla collezione "Aboutwater" Boffi+Fantini

Per un elenco completo ed aggiornato dei
rivenditori, si prega di contattare
customercare@salvatori.it o di visitare il sito
salvatori.it nell'area Find A Dealer.

salvatori.it

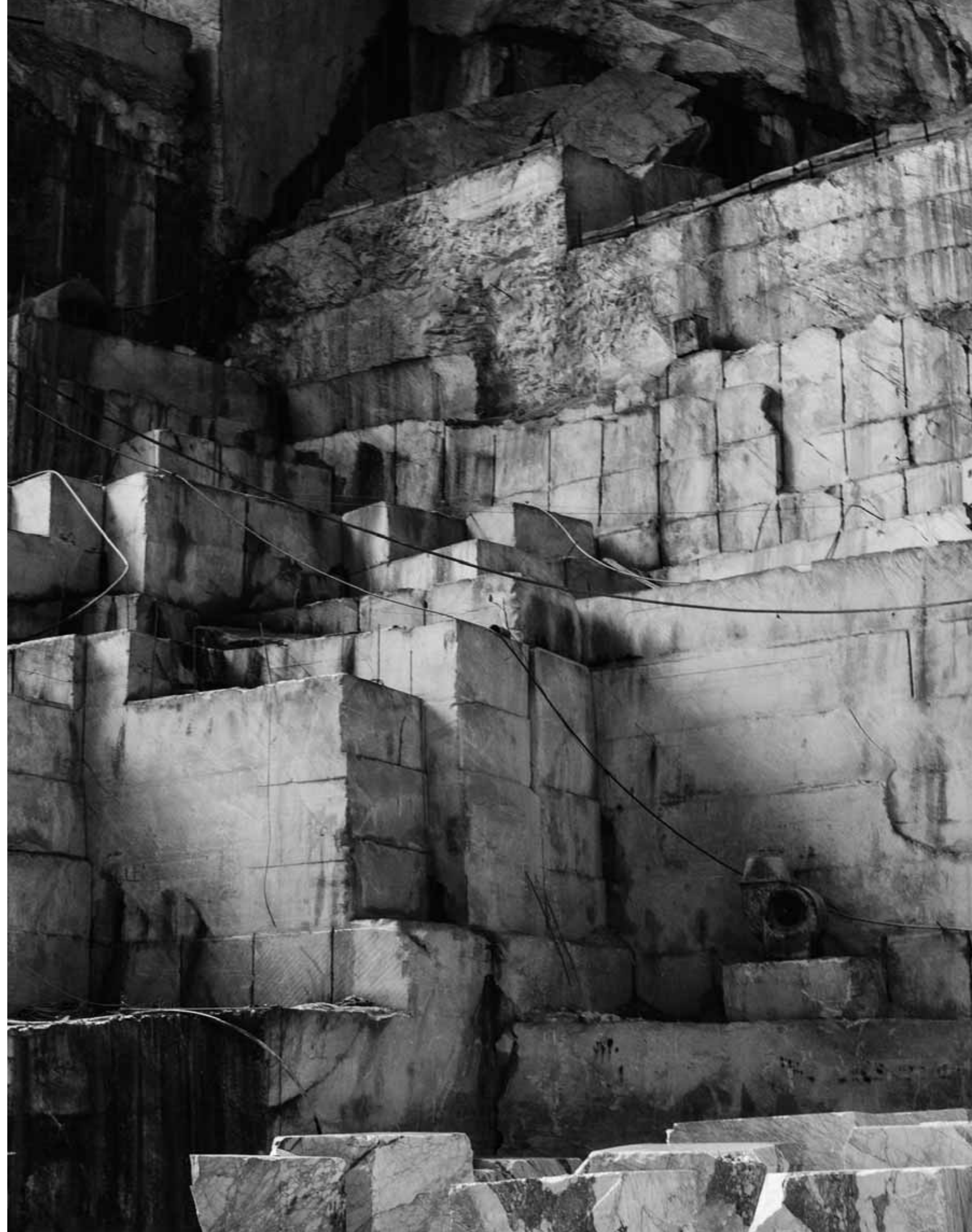

SALVATORI

DAL 1946



Head Office

via Aurelia 395/E
55047 Querceta (LU)
ITALY
T: +39 0584 769 200
info@salvatori.it

Showrooms

Via Solferino 11
Milan
ITALY
T: +39 02 8050 0372
milano@salvatori.it

Hardturmstrasse 169
Zurich
SWITZERLAND
T: +41 44 271 3702
zurich@salvatori.it

26 Wigmore St
London
UNITED KINGDOM
info@salvatoriuk.com

318 Liverpool St
Darlinghurst, Sydney
AUSTRALIA
T: +61 2 8521 5001
info@salvatori.au.com